



## Multi-Purpose Torch

English USA – en  
Model #R3A21  
rB

## INSTRUCTION MANUAL

Thank you for purchasing the Ronson® Multi-Purpose Torch ("Product"). **READ ALL WARNINGS AND INSTRUCTIONS** before using your Product for the first time. Improper use of this Product may result in Product damage, for which damages you ("Purchaser") and not Zippo Manufacturing Company ("Zippo") are responsible.

## WARNING

**DANGER: EXTREMELY FLAMMABLE. CONTENTS UNDER PRESSURE. KEEP OUT OF THE REACH OF CHILDREN.**

Do not puncture or incinerate container. Do not expose to heat or store at temperatures above 120°F (49°C).

Do not use near sparks or open flame. Do not store in direct sunlight.

**⚠WARNING: KEEP LIGHTERS AND THEIR FUELS OUT OF REACH OF CHILDREN.** Ignite away from face and clothing. Do not use to light cigarettes, cigars, or pipes. Be sure flame is out after use. Never expose to heat above 120°F (49°C) or to prolonged sunlight. Never puncture or put in fire. Extreme heat is present above the visible flame. Extra care should be taken to prevent burn, injury, or fire. Follow all instructions and warnings provided by manufacturer of appliance or any other item when using this product. Do not operate continuously for more than 10 minutes. Wait 2 minutes after refilling before using the torch. When filled, will contain flammable gas under pressure. Do not refuel over containers such as sinks or near flame. Butane tends to settle and collect in the lowest point.

2

## Multi-Purpose Torch

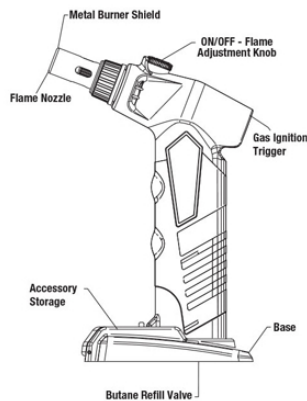

[Figure A]

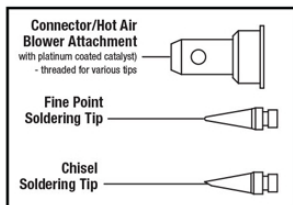

[Figure B]

3

## FILLING THE PRODUCT

- For best performance, we recommend high-quality butane fuel like Ronson or Zippo to fill and refill. Use of other low-quality butane fuels may result in damage to the filling valve and could cause clogging.
- Before filling, ensure that Product is extinguished.
- Allow sufficient time for the Product to cool to room temperature before refilling.
- Do not refuel over containers such as sinks or near a flame. Butane tends to settle and collect in the lowest point.
- Hold the product with the Butane Refill Valve up.
- For safe filling: ensure proper mating between fuel can and Refill Valve.
- Invert the fuel can and insert the tip of the butane into the Product Refill Valve. (Figure C)
- Apply firm pressure to allow fuel to flow into the Product's fuel tank until full.
- Do not overfill.
- After filling the Product, allow at least 2 minutes for the butane to stabilize before igniting.

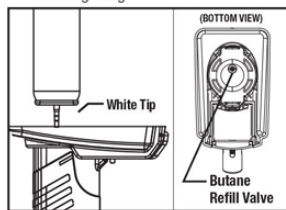

[Figure C]

4

The Product produces a precision blue flame suitable for various hobby and household projects including soldering, heating, melting, and thawing. Not intended for commercial use or for extended periods of burn time.

## OPERATING INSTRUCTIONS

(Without Connector/Blower Attachment)

**WARNING:** When using, ignite away from face and clothing. Be sure flame is out after use.

- Push downward the On/Off Flame Adjustment Knob and then rotate Counterclockwise until fuel begins to release (Figure D)
- Depress the Ignition Button to ignite the flame. (Figure E)
- To adjust the Flame Size, Rotate the Flame Adjustment Knob Counterclockwise to increase the flame or Clockwise to decrease the flame. (Figure F)
- Do not operate continuously for more than 10 minutes.

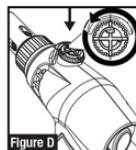

[Figure D]

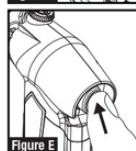

[Figure E]

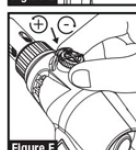

[Figure F]

5

- To Shut off, rotate the On/Off Flame Adjustment Knob Clockwise until the flame extinguishes and the knob returns to the upright position. (Figure G)

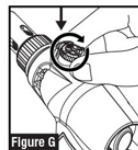

[Figure G]

## OPERATING INSTRUCTIONS

(With Connector/Blower Attachment and Tips)

- Be sure the Product is completely cool.
- Turn the Burner Shield Lock Collar counterclockwise to remove the Metal Burner Shield. (Figure H)
- Slide the Metal Burner Shield and Lock Collar off the Flame Nozzle. (Figure I)
- Fully Insert the Connector/Hot Air Blower Attachment into the Metal Burner Shield. (Figure I)
- Slide the Metal Burner Shield/Connector assembly and Lock Collar back onto the Flame Nozzle. (Figure I)
- Turn the Burner Shield Lock Collar Clockwise to tighten and secure the Metal Burner Shield to the Torch Housing. (Figure I)

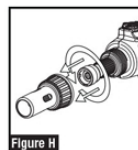

[Figure H]

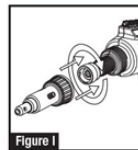

[Figure I]

6

NOTE: Accessory Tip may be added at this point.

**WARNING:** Be sure Connector/Hot Air Blower is completely cool before attaching any accessory tip to prevent burns or severe injury.

- Push downward the On/Off Flame Adjustment Knob and then rotate Counterclockwise until fuel begins to release. (Figure J)

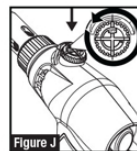

[Figure J]

- Depress the Ignition Button to ignite the flame. (Figure K)

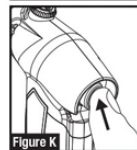

[Figure K]

- To adjust the Hot Air/Accessory Tip Temperature, Rotate the Flame Adjustment Knob Counterclockwise to increase the flame or Clockwise to decrease the flame. (Figure L)

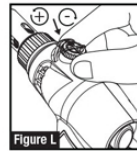

[Figure L]

- Do not operate continuously for more than 10 minutes.

- To Shut off, rotate the On/Off Flame Adjustment Knob Clockwise until the flame extinguishes and the knob returns to the upright position. (Figure M)

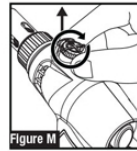

[Figure M]

7

## Accessory Storage:

The Product Base provides a compartment for storage. To access the Accessory Tips, pull forward on the compartment lid lock tab and rotate the lid open. The Accessory Tips may be inserted in the proper storage slots as show in the below figure.

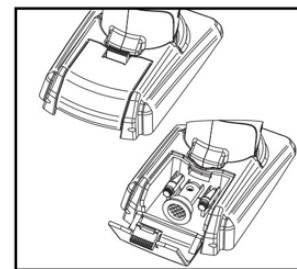

## Base Removal

The Product Base may be removed.

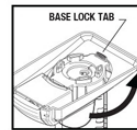

## Remove

- With the base facing up, apply outward pressure on the base lock tab.
- Rotate the rear of the base off the product as shown in the figure.

## Installation

- Firmly hold the Base and insert the Product, ensuring the base lock properly engages.

NOTE: Be sure base is properly attached to ensure the Product is properly supported during use.

8

## ONE YEAR LIMITED WARRANTY

Zippo Manufacturing Company warrants the Product against manufacturing defects in material and workmanship under normal use. This warranty does not cover, and Zippo shall have no liability with respect to, damage, failure or loss caused by or attributable to abuse, accident, misuse, improper or abnormal use, neglect, improper or unauthorized repair, failure to follow instructions provided by Zippo or "acts of God" or other contingencies beyond the control of Zippo. This warranty does not cover the incidental or consequential damages, although some states do not allow the exclusion or limitation of incidental or consequential damages, so the above limitation or exclusion may not apply to you.

Warranty coverage extends to the original purchase and begins on the date of purchase and ends one (1) year thereafter. Other than as to the foregoing, this warranty is in lieu of all other express and implied warranties. Any implied warranties which by law cannot be excluded are limited to this same period. Some states do not allow limitations on how long an implied warranty lasts, so the above limitation may not apply to you. This warranty gives you specific legal rights, and you may also have other rights which vary from state to state. To obtain proper instructions for service under this limited warranty, refer to repair instructions at zippo.com or contact Zippo Consumer Relations at consumerrelations@zippo.com or 1-888-442-1932. **Do not return the Product to the retail store.** If the Product is covered by the warranty, Zippo will repair or replace the item or will refund the purchase price. Any attempt to disassemble the Product by user or any non-approved repair center will void this warranty.

NOTE: Proof of purchase is required for warranty service.

9

Zippo Manufacturing Company

33 Barbour Street  
Bradford, Pa 16701

zippo.com

© 2023 Zippo Manufacturing Company